



COUNTIS E2x

Active-energy meters

three-phase - direct 80 A

Single-circuit metering,
measurement &
analysis



COUNTIS E24 - MID

The solution for

- > Industry
- > Infrastructure
- > Data center
- > EV Chargers
- > Shopping centers



Function

The **COUNTIS E2x** is a modular energy meter displaying the energies (kWh, kVAh and kVA) and other measurements directly on its backlit LCD display. It is designed for three-phase networks and allows a direct connection of up to 80 A.

Advantages

RS485 (MODBUS), M-BUS, Ethernet communication or pulse outputs

To easily centralise your consumption, COUNTIS E2x devices have either one pulse output, one RS485 (MODBUS), M-BUS or an Ethernet Modbus TCP communication output. With RS485 and Ethernet communication models, you can configure your meters remotely.

Multi-tariff

Lets you assign different time slots (every hour, dip times) or different sources (normal, back-up) to your energy readings to monitor your energy consumption in more detail.

MID certified B+D module

COUNTIS E units comply with the MID directive to guarantee accuracy and reliability when metering, compulsory for energy billing applications. "Module B+D" certification guarantees that the design and manufacturing process of products are approved by an accredited laboratory.

Functional diagram

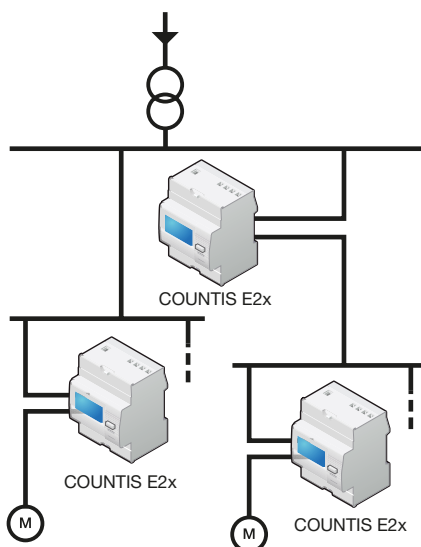

count_224_a_1_x_cat.eps

Common characteristics

- Measurement accuracy: 1%.
- Displayed on backlit screen.
- Multi-measurement available on display.

Strong points

- > RS485 (MODBUS), M-BUS, Ethernet or pulse outputs
- > Multi-tariff
- > MID certified B+D module
- > Multi-measurement on display
- > Bi-directional metering

MID certification

- > COUNTIS E units comply with the MID directive to guarantee accuracy and reliability when metering, compulsory for energy billing applications.
- > COUNTIS E MID feature tamper-proof components to prevent fraud.



Conformity to standards

- > IEC 62053-21 class 1
- > IEC 62053-23 class 2
- > IEC 62053-31
- > IEC 62052-11
- > EN 50470-1
- > EN 50470-3



Models	Model-related specifications
E21	Dual tariff + pulse output
E22	Dual tariff + pulse output + MID
E23	Dual tariff + pulse output + MODBUS RS485 communication
E24	Dual tariff + pulse output + MODBUS RS485 communication + MID
E25	Dual tariff + pulse output + M-BUS communication
E26	Dual tariff+ pulse output + M-BUS communication + MID
E27	Dual tariff + pulse output + Ethernet
E28	Dual tariff + pulse output + Ethernet + MID

Front panel

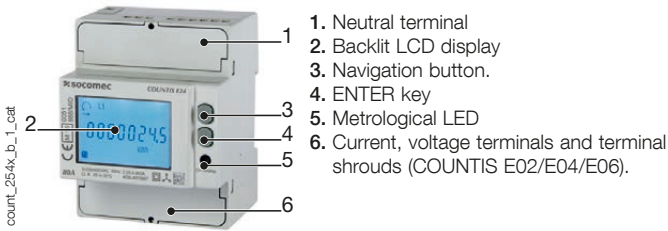

Dimensions (mm)

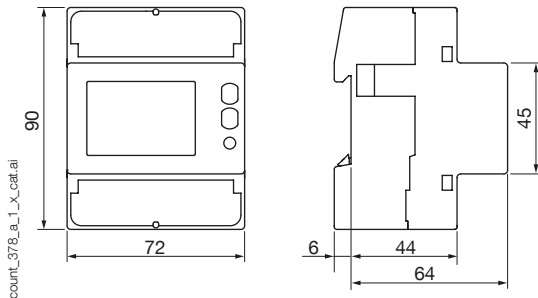

Type	modular
Number of modules	4
Dimensions W x H x D	72 x 90 x 64 mm
Case degree of protection	IP 20
Front degree of protection	IP 51 ⁽¹⁾
Display type	8-digit backlit LCD
Rigid cable cross-section	1.5 ... 35 mm ²
Flexible cable cross-section	1.5 ... 35 mm ²
Weight	440 g

(1) For the installation in a cabinet at least with IP51 protection.

Electrical characteristics

Measurement of currents

Type	three-phase - direct 80 A
Input consumption	0.5 VA max. per phase
Startup current (I _{st})	20 mA
Minimum current (I _{min})	0.25 A
Transition current (I _{tr})	0.5 A
Reference current (I _{ref})	5 A
Permanent overload (I _{max})	80 A
Intermittent overload	30 I _{max} over 10 ms

Voltage measurement

Range of measurement	230 ... 240 V ±20%
Consumption (VA)	7.5 VA max (0.5 W) per phase E21/E22/E25/E26 3.5 VA max (1 W) per phase E23/E24/E27/E28
Permanent overload	290 V phase-neutral / 500 V phase-phase

Energy accuracy

Active (according to IEC 62053-21)	Class 1
Active (according to EN 50470)	Class B
Reactive (according to IEC 62053-22)	Class 2

Power supply

Self-powered	Yes
Frequency	50/60 Hz

Output (pulses)

Optoisolated type (IEC 62053-31)	250 VAC/DC - 100 mA (E21/E22) 27 VDC - 27 mA (E23 ... E28)
Number	2 (E21/E22) 1 (E23 ... E28)
Fixed pulse weight	100 Wh
Pulse duration	50 ± 2 ms ON time 30 ± 2 ms OFF time

Operating conditions

Operating temperature	-25 ... 55°C
Storage temperature	-25 ... 75°C
Relative humidity	80%

Communication	COUNTIS E23/24	COUNTIS E25/E26	COUNTIS E27/E28
Link	RS485	Wired	RJ45
Type	2 half duplex 2 to 3 half duplex (E23/E24)		Full duplex
Protocol	MODBUS RTU	M-BUS	MODBUS TCP, HTTP, NTP, DHCP
Baudrate	1200 ... 115200 bauds	300 ... 9600 bauds	10/100 Mbps

Connection

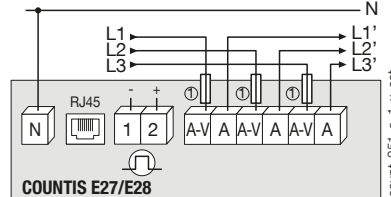
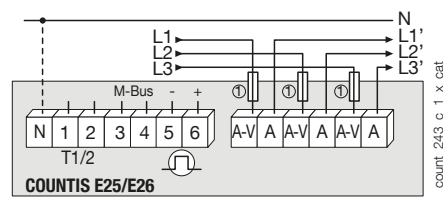
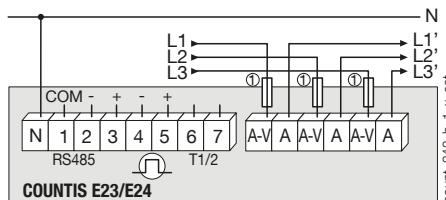
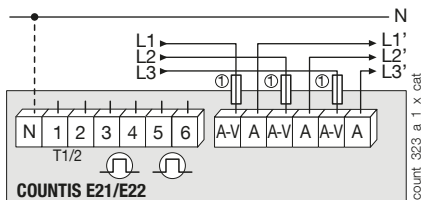

WARNING: The neutral conductor must be connected on models COUNTIS E23 / E24 / E27 / E28 (the neutral conductor is represented by the solid line in the image opposite).

The neutral conductor is optional on models COUNTIS E21 / E22 / E25 / E26 (the neutral conductor is represented by the dashed line in the image opposite).

References

Type	COUNTIS E21 Reference	COUNTIS E22 Reference	COUNTIS E23 Reference	COUNTIS E24 Reference	COUNTIS E25 Reference	COUNTIS E26 Reference	COUNTIS E27 Reference	COUNTIS E28 Reference
Direct 80 A - Dual tariff	4850 3062							
Direct 80 A - Dual tariff + MID		4850 3049						
Direct 80 A - Dual tariff + MODBUS communication via RS485			4850 3050					
Direct 80 A - Dual tariff + MODBUS communication via RS485 + MID				4850 3051				
Direct 80 A - Dual tariff + M-Bus communication					4850 3052			
Direct 80 A - Dual tariff + M-Bus communication + MID						4850 3053		
Direct 80 A - Dual tariff + Ethernet Modbus TCP communication							4850 3054	
Direct 80 A - Dual tariff + Ethernet Modbus TCP + MID								4850 3055

Accessories	To be ordered in multiples of	Reference
Panel mounting kit 4 modules		192J 8015
10x 1U sealing kits		4850 309U
Fuse disconnect switches to protect 3-pole voltage inputs (RM type)	2	5703 5003
gG 22x58 80 A fuses	10	6032 0080