

# SINGLE PHASE DIN RAIL ENERGY METER

## COUNTIS M13

### MANUAL V1.1



## Statement

All rights reserved. Without the written permission of SOCOMEC, the contents of any pages and chapters in this manual shall not be copied or reproduced or disseminated in any form. Otherwise, all consequences shall be borne by the violator.

SOCOMECC reserves all legal rights.

SOCOMECC reserve the right to modify the product specifications described in this manual without prior notice. Before ordering, please contact our company or local agent for the latest specifications of this product.

# Contents

## **Part 1 Product overview**

1.1 Brief Introduction -----1

1.2 Product characteristics -----1

1.3 Application -----1

## **Part 2 General Specifications**

2.1 Specifications-----2

2.2 Accuracy -----2

2.3 RS485 Communication-----3

2.4 Environment-----3

2.5 Dimensions-----4

2.6 Wiring Diagram-----4

## **Part 3. Operation Instructions**

3.1 Display and Operation-----5

3.1.1 Display -----5

3.1.2 Button Definition-----5

3.2 Measurement-----5

3.3 Setting by button-----9

**Part 4. Modbus register Map-----14**

## **Part 1 Product overview**

### 1.1 Brief Introduction

COUNTIS M13 energy-meter “with a white back-lighted LCD screen for perfect reading” are used to measure single-phase like residential, utility and Industrial application. The unit measures and displays various important electrical parameters; provide a RS485 communication port for remote reading and monitoring. Bi-directional energy measurement makes the unit a good choice for solar PV energy metering. The compact design and DIN rail installation provides an easy and economical solution for your metering demand.

COUNTIS M13 equipped with 2 channels of pulse output. The pulse constant, pulse width and output unit is configurable. Built-in interfaces provides RS485 Modbus RTU outputs, RS485 high-speed communication supports the highest communication rate of 9600 bps, it is an ideal choice for power energy monitoring. Configuration is password protected.

### 1.2 Product characteristics

- Measures kWh, Kvarh, KW, Kvar, KVA, PF, Hz, dmd, V, A, etc.
- Bi-directional measurement IMP & EXP
- Two pulse outputs
- RS485 Modbus
- 100A direct connection

### 1.3 Application

COUNTIS M13 is a multi-functional single phase energy meter, designed for power system, public facilities, industrial applications and residential power monitoring needs. It can also be used in AC charging pile, solar photovoltaic and other occasions. Its complete communication function makes it very suitable for real-time power monitoring systems.

## Part 2 General Specifications

### 2.1 Specifications

- ◆ Voltage: Rated Voltage (  $U_n$  ) : 230V AC  
Operational voltage:  $\pm 20\%$  of  $U_n$
- ◆ Current: Rated Current ( $I_b$ ): 5A  
Max Current ( $I_{max}$ ): 100A  
Over current withstand: 30  $I_{max}$  for 0.01s
- ◆ Operational frequency: Rated: 50/60Hz  
Range: 45-65 Hz
- ◆ Insulation capabilities: AC voltage withstand 4KV/1min  
Impulse voltage withstand 6kV – 1.2 $\mu$ S waveform
- ◆ Internal Power Consumption:  $\leq 2W$ .
- ◆ Pulse Output 1: Configurable
- ◆ Pulse Output 2: Fixed 1000imp/kWh
- ◆ Display: LCD with backlit
- ◆ Max reading: 999999.9 kWh

### 2.2 Accuracy

- ◆ Voltage: 0.5%
- ◆ Current: 0.5%
- ◆ Frequency: 0.2%
- ◆ Power Factor: 1%
- ◆ Active Power: 1%
- ◆ Reactive Power:  $\pm 1\%$

- ◆ Apparent power:  $\pm 1\%$
- ◆ Active energy: Class1
- ◆ Reactive energy: Class2

### 2.3 RS485 Communication

- ◆ Bus Type: RS485
- ◆ Communication Protocol: Modbus RTU
- ◆ Baud rate: 1200/2400/4800/9600bps
- ◆ Modbus Address: 1-247
- ◆ Bus load: 64pcs
- ◆ Communication distance: 1000m
- ◆ Parity: EVEN /ODD/NONE
- ◆ Data bit: 8
- ◆ Stop bit: 1

### 2.4 Environment

- ◆ Operating humidity:  $\leq 90\%$
- ◆ Storage humidity:  $\leq 95\%$
- ◆ Operating temperature:  $-25^{\circ}\text{C}\sim+55^{\circ}\text{C}$
- ◆ Storage temperature:  $-40^{\circ}\text{C}\sim+70^{\circ}\text{C}$
- ◆ Standard: IEC 63052-11/IEC62053-21
- ◆ Accuracy: Class 1
- ◆ Installation category: CAT II
- ◆ Protection against penetration of dust and water: IP51 (indoor)
- ◆ Insulating encased meter of protective class: II
- ◆ Altitude:  $\leq 2000\text{m}$

2.5 Dimensions

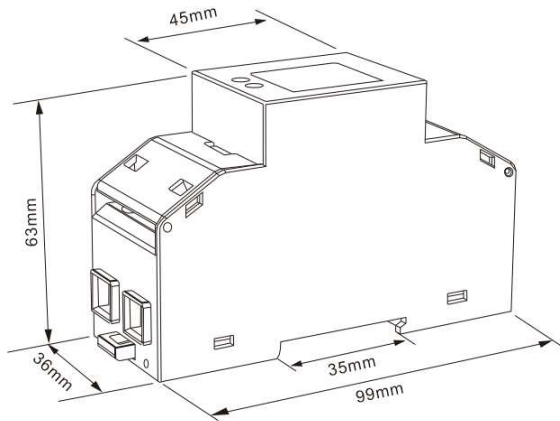

Height: 63 mm

Width: 36 mm

Length: 99 mm

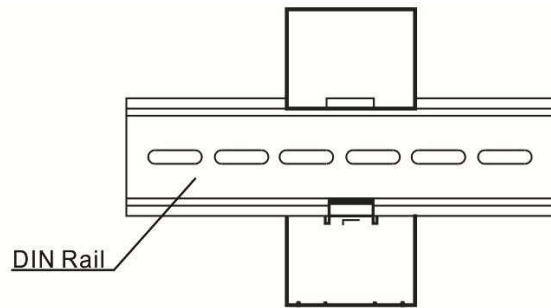
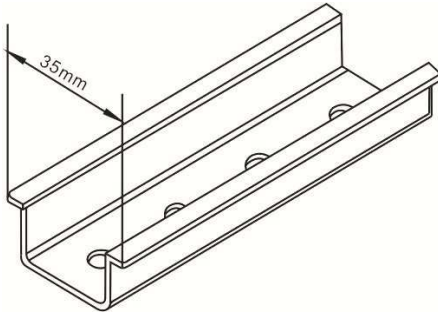

2.6 Wiring Diagram

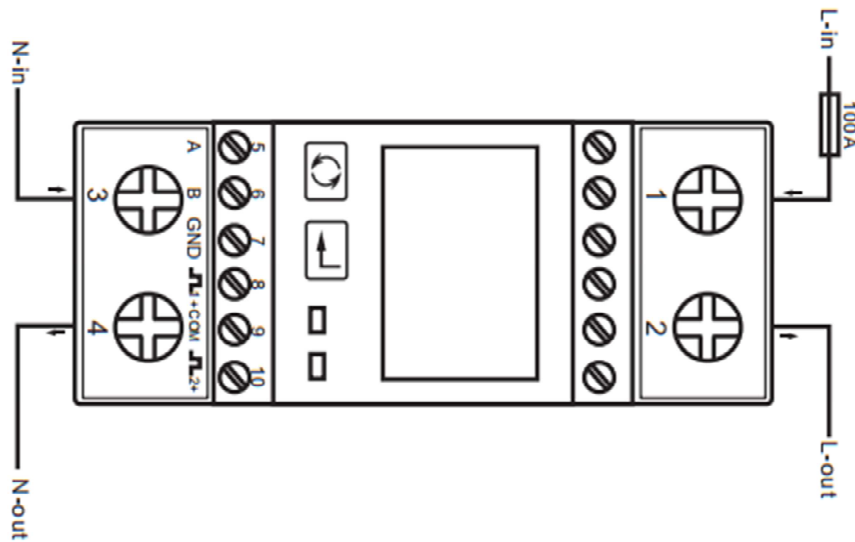

### Part 3. Operation Instructions

#### 3.1 Display and Operation



##### 3.1.1 Display

When the meter is powered on, the meter will initialize and do self-checking

Display as following:

1	<b>Full screen</b>
2	Software version
3	Modbus Address
4	Baud rate
5	Total active energy(kWh)

##### 3.1.2 Button Definition

	<ul style="list-style-type: none"> <li>◆ In measurement mode: Click the button, the LCD display will scroll the measurements;</li> <li>◆ In Set mode: Click the button to Switch the menu of the same level or increase the number of digits; Long press to get out of set-up menu and return to the menu of the previous level.</li> </ul>
	<ul style="list-style-type: none"> <li>◆ In measurement mode, Click the button: unlock/lock, communication setting function; long press to enter setting mode;</li> <li>◆ In setting mode, Click the button to move cursor (The cursor is the number bit that is flickering in setting state); Long press for the menu item selection confirmation and parameter modification confirmation.</li> </ul>





#### 3.2 Measurement







Click the button, the LCD display will scroll the measurements.





Total kWh → Import kWh → Export kWh → Resettable kWh → Total KVarh → Import KVarh → Export KVarh →

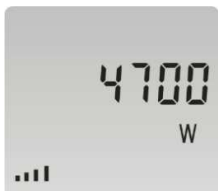

Resettable kVarh →Max. Power Demand →Voltage →Current→W→Var→VA→Power factor →  
 Frequency→Pulse Constant→Modbus ID →Baud rate → Continuous Running Time

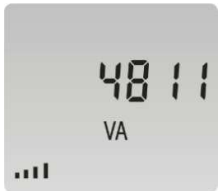
Item	Display	Description
1		Total kWh Example: 70.00kWh
2		Import kWh Example: 50.00kWh
3		Export kWh Example: 20.00kWh
4		Resettable kWh Example: 2.68kWh
5		Total KVarh Example: 10.00kVarh
6		Import KVarh Example: 5.00kVarh

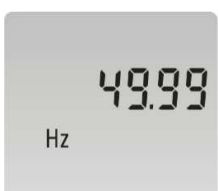

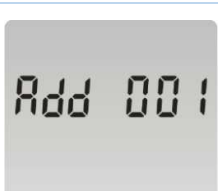
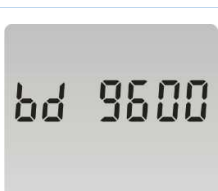
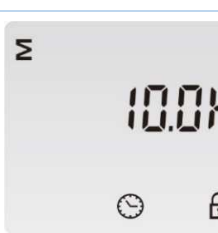



7		<p>Export KVarh</p> <p>Example: 5.00kVarh</p>
8		<p>Resettable kVarh</p> <p>Example: 1.49kVarh</p>
9		<p>Max. Power Demand</p> <p>Example: 6930W</p>
10		<p>Voltage</p> <p>Example: 229.8V</p>
11		<p>Current</p> <p>Example: 30.156A</p>
12		<p>Active Power (W)</p> <p>Example: 4700W</p>
13		<p>Reactive Power (Var)</p> <p>Example: 1030Var</p>



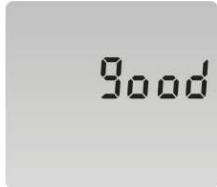

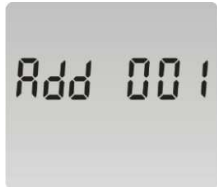





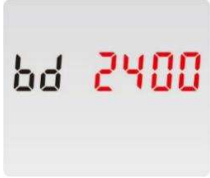

14		<p>Apparent power</p> <p>Example: 4811VA</p>
15		<p>Power factor</p> <p>Example: 1.000</p>
16		<p>Frequency</p> <p>Example: 49.99Hz</p>
17		<p>Pulse Constant</p> <p>Example: 1000</p>
18		<p>Modbus ID</p> <p>Example: 001</p>
19		<p>Baud rate</p> <p>Example: 9600</p>
20		<p>Continuous Running Time</p>

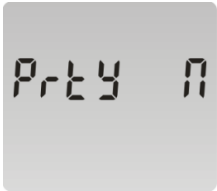
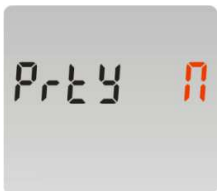



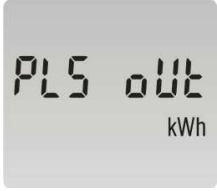
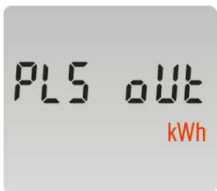





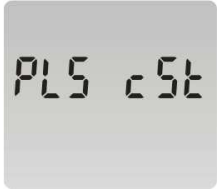
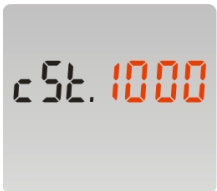

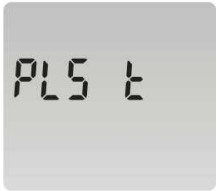

### 3.3 Setting by button





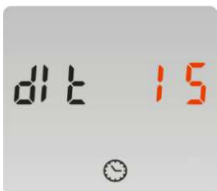



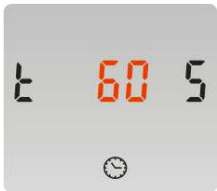

To get into Set-up Mode, the user needs to press the “Enter “button  for 3 second.



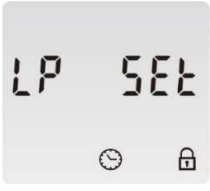



Below parameters can be set via the buttons.

Item	Display	Description
1		Setting successfully, it displays “good”
2		Setting failed, it displays ” err”
3		Password: The user shall enter the password to enter the Set-mode  Default: 1000
4		Modbus ID:  Default: 001  Ranges: 001~247
4-1		Press  button to enter the selection routine. The current setting will be flashing.  Use buttons  to choose Modbus Address (001 to 247). Press  to confirm the new ID.

5		<p><b>Baud Rate</b></p> <p>Default: 2400bps</p> <p>Options: 1200, 2400, 4800, 9600bps.</p>
5-1		<p>Press  button to enter the selection routine. The current setting will be flashing.</p> <p>Use buttons  to choose Baud rate. Press  to confirm the new Baud rate.</p>
6		<p><b>Parity</b></p> <p>Default: None</p> <p>Options: None, Even, Odd</p>
6-1		<p>Press  button to enter the selection routine. The current setting will be flashing.</p> <p>Use buttons  to choose Parity. Press  to confirm the new Parity.</p>
7		<p><b>Pulse Output 1</b></p> <p>Default: kWh</p> <p>Options : kWh / KVarh / Imp. Kwh / Exp.kWh / Imp.kVarh / Exp.kVarh</p>
7-1		<p>Press  button to enter the selection routine. The current setting will be flashing.</p> <p>Use buttons  to choose Pulse Output.</p> <p>Press  to confirm the Pulse Output.</p>

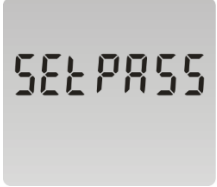
8		<p><b>Pulse Constant</b></p> <p>Default: 1000</p> <p>Options: 1000 / 100 / 10 / 1</p>
8-1		<p>Press  button to enter the selection routine. The current setting will be flashing.</p> <p>Use buttons  to choose Pulse Constant.</p> <p>Press  to confirm the Pulse Constant.</p>
9		<p><b>Pulse Duration</b></p> <p>Default: 100ms</p> <p>Options: 200 / 100 / 60ms</p>
9-1		<p>Press  button to enter the selection routine. The current setting will be flashing.</p> <p>Use buttons  to choose Pulse duration.</p> <p>Press  to confirm the Pulse duration.</p>
10		<p><b>Demand Integration Time</b></p> <p>Default: 15 minutes</p> <p>Options: 0 / 5 / 10 / 15 / 30 / 60</p>
10-1		<p>Press  button to enter the selection routine. The current setting will be flashing.</p> <p>Use buttons  to choose DIT. Press  to confirm the DIT.</p>

11		<p>Automatic Scroll Time Interval</p> <p>Default: 0 S</p> <p>Options: 0 ~ 30S</p>
11-1		<p>Press  button to enter the selection routine. The current setting will be flashing. Use buttons  to choose Automatic Scroll Time Interval.</p> <p>Press  to confirm Automatic Scroll Time Interval.</p>
12		<p>Backlit lasting time</p> <p>Default:60mins</p> <p>Options: 0 (off)/5/10/20/30/60</p>
12-1		<p>Press  button to enter the selection routine. The current setting will be flashing. Use buttons  to choose backlit lasting time. Press  to confirm backlit lasting time.</p>
13		<p>Press  button for 3 seconds to clear</p>

13-1		Clear Max demand of active power
13-2		Clear the resettable energy kWh/kVarh
14		<p>Password</p> <p>Default: 1000</p>
14-1		<p>Press  button to enter the selection routine. The current setting will be flashing. Use buttons  to enter new password. Press  to new password.</p>



#### Part 4. Modbus register Map

Function code	
04	to read input parameters

Address (Register)	Input Register	Parameter		Modbus Protocol Start		Address Hex
	Parameters	unit	format	Hi byte	Lo byte	
0001	Voltage	Volts	Float	00	00	
0007	Current	Amps	Float	00	06	
0013	Active power	Watts	Float	00	0C	
0019	Apparent power	VA	Float	00	12	
0025	Reactive power	VAr	Float	00	18	
0031	Power factor	No	Float	00	1E	
0071	Frequency	Hz	Float	00	46	
0073	Import active energy	kWh	Float	00	48	
0075	Export active energy	kWh	Float	00	4A	
0077	Import reactive energy	kvarh	Float	00	4C	
0079	Export reactive energy	kvarh	Float	00	4E	
0085	Total system power demand	W	Float	00	54	
0087	Maximum total system power demand	W	Float	00	56	
0089	Import system power demand	W	Float	00	58	
0091	Maximum Import system power demand	W	Float	00	5A	
0093	Export system power demand	W	Float	00	5C	
0095	Maximum Export system power demand	W	Float	00	5E	
0259	current demand	Amps	Float	01	02	
0265	Maximum current demand.	Amps	Float	01	08	
0343	Total active energy	kWh	Float	01	56	
0345	Total reactive energy	Kvarh	Float	01	58	
0385	Resettable total active kWh	kwh	Float	01	80	
0387	Resettable total active kVarh	kvarh	Float	01	82	

Function code	
10	to set holding parameter
03	to read holding parameter

Address Register	Holding Register Parameter		Modbus Protocol Start Address Hex		Description
	Parameters	Format	Hi byte	Lo byte	
0013	Pulse 1 Width	Float	00	0C	Write Pulse 1 Width in milliseconds: 60, 100 or 200, default 60ms.  <b>Length : 4 byte</b>  <b>Data Format : Float</b>
0019	Network Parity Stop	Float	00	12	Write the network port parity/stop bits for MODBUS Protocol. where: 0 = One stop bit and no parity,  1 default.= One stop bit and even parity.  2 = One stop bit and odd parity.      3 = Two stop bits and no parity. Requires a restart to become effective.  <b>Length : 4 byte</b>  <b>Data Format : Float</b>
0021	Meter ID	Float	00	14	Ranges from 1 to 247. Default ID is 1.  <b>Length : 4 byte</b>  <b>Data Format : Float</b>
0025	Pass word	Float	00	18	Meter Pass word ( only read) Default: 1000.  <b>Length : 4 byte</b>  <b>Data Format : Float</b>
0029	Baud rate	Float	00	1C	Write baud rate for MODBUS Protocol, where:

					<p>0 = 2400 baud (default)  1 = 4800 baud.    2 = 9600 baud    5=1200 baud.</p> <p><b>Length : 4 byte</b></p> <p><b>Data Format : Float</b></p>
0087	Pulse 1 output mode	Float	00	56	<p>Write MODBUS Protocol input parameter for pulse out 1:</p> <p>0001: Import active energy,  0002: Total active energy ( Imp + exp)  0004: Export active energy, (default).  0005: Import reactive energy,  0006:Total reactive energy (Imp+ exp)  0008: Export reactive energy,</p> <p><b>Length : 4 byte</b></p> <p><b>Data Format : Float</b></p>
61457	Reset historical data	Hex	F0	10	<p>00 00: reset demand info</p> <p><b>Length : 2 byte</b></p> <p><b>Data Format : Hex</b></p>
62721	Demand Period, Sliding time and Time of scroll display and backlit lasting time	BCD	F5	00	<p>Parameter format:</p> <p>The first byte is for Demand Period, unit: minute. Options:0~60 (0 means the demand won't be update)  Default: 15</p> <p>The second byte is for sliding time unit: minute. Options 1~ (Demand Period-1) Default: 1</p> <p>The third byte is for Time of scroll display. Unit: second. Options: 0~30.  0 means the scroll display function is</p>

					<p>closed. Without scrolling. Default: 0</p> <p>The forth byte is for backlit lasting time.</p> <p>Unit: minute. Options: 0~60.</p> <p>0 means the backlit is always on.</p> <p>Default: 60</p> <p><b>Length : 4 byte</b></p> <p><b>Data Format : BCD</b></p>
63761	Pulse 1 output	Hex	F9	10	<p>0000:0.001kWh/imp( default)</p> <p>0001:0.01kWh/imp</p> <p>0002:0.1kWh/imp</p> <p>0003:1kWh/imp</p> <p><b>Length : 2 byte</b></p> <p><b>Data Format : HEX</b></p>
63776	Measurement mode	Hex	F9	20	<p>0001:mode 1(total = import)</p> <p>0002:mode 2 (total = import + export ) (default)</p> <p>0003:mode 3 (total = import - export)</p> <p><b>Length : 2 byte</b></p> <p><b>Data Format : HEX</b></p>
63792	Continuous Running Time	Float	F9	30	<p>Continuous Running Time</p> <p><b>Length : 4 byte</b></p> <p><b>Data Format : float</b></p>
64513	Serial number	Unsigned int32	FC	00	<p><b>Serial number ( only read)</b></p> <p><b>Length : 4 byte</b></p> <p><b>Data Format :Unsigned int32</b></p>