

THREE PHASE DIN RAIL ENERGY METER

COUNTIS M43

MANUAL V1.1



Statement

All rights reserved. Without the written permission of SOCOMEC, the contents of any pages and chapters in this manual shall not be copied or reproduced or disseminated in any form. Otherwise, all consequences shall be borne by the violator.

SOCOMECE reserves all legal rights.

SOCOMECE reserve the right to modify the product specifications described in this manual without prior notice. Before ordering, please contact our company or local agent for the latest specifications of this product.

Contents

Part 1. Product overview

1.1 Brief Introduction	1
1.2 Product characteristics	1
1.3 Application	2

Part 2. General Specifications

2.1 Specifications	3
2.2 Accuracy	3
2.3 RS485 Communication	4
2.4 Environment	4
2.5 Dimensions	5
2.6 Wiring Diagram	5

Part 3. Operation Instructions

3.1 Display and Operation	6
3.1.1 Button Definition	6
3.2 Measurement	6
3.2.1 Voltage & Current	6
3.2.2 Frequency, Power Factor & Demand	8
3.2.3 Power	9
3.2.4 Energy	10
3.3 Setting by button	11
3.3.1 Button Operation	13
3.3.2 Number Entry Procedure	13
3.3.3 Set Password	14

3.3.4 Modbus Address-----	14
3.3.5 Baud Rate-----	15
3.3.6 Parity-----	15
3.3.7 Stop Bit-----	16
3.3.8 CT Setting-----	17
3.3.9 PT Setting-----	18
3.3.10 Pulse output-----	19
3.3.11 Pulse Constant-----	19
3.3.12 Pulse Duration-----	20
3.3.13 Set DIT -----	21
3.3.14 Set backlit lasting time-----	22
3.3.15 Set System-----	23
3.3.16 Clear-----	24
Part 4. Modbus register Map-----	25

Part 1 Product overview

1.1 Brief Introduction

COUNTIS M43 measures and displays the characteristics of single phase two wires (1p2w), three phase three wires(3p3w,) and three phase four wires(3p4w) supplies, including voltage, frequency, current, power ,active and reactive energy, imported or exported. Energy is measured in terms of kWh, kVArh. Maximum demand current can be measured over preset periods of up to 60minutes. In order to measure energy, the unit requires voltage and current inputs in addition to the supply required to power the product. The requisite current input(s) are obtained via current transformers(CT).

This meter can be configured to work with a wide range of CTs, giving the unit a wide range of operation. Built-in interfaces provides pulse and RS485 Modbus RTU outputs. Configuration is password protected.

This unit can be powered from a separate auxiliary (AC) supply. Alternatively it can be powered from the monitored supply, where appropriate.

1.2 Product characteristics

- Measures kWh Kvarh, KW, Kvar, KVA, P, F, PF, Hz, dmd, V, A, THD, etc.
- Bi-directional measurement IMP & EXP
- Two pulse outputs
- RS485 Modbus
- Din rail mounting 35mm
- 1/5A CT connection
- Class 0.5S

The Unit can measure and display:

- Line voltage and THD% (total harmonic distortion) of all phases
- Line Frequency
- Currents, Current demands and current THD% of all phases
- Power, maximum power demand and power factor
- Active energy imported and exported
- Reactive energy imported and exported

The unit has password-protected set-up screens for:

- Changing password
- Supply system selection 1p2w, 3p3w,3p4w
- Demand Interval time
- Reset for demand measurements
- Pulse output duration

Two pulse output indicates real-time energy measurement. An RS485 output allows remote monitoring from another display or a computer.

1.3 Application

COUNTIS M43 is a multi-functional three phase energy meter, designed for power system, public facilities, industrial applications and residential power monitoring needs. It can also be used in AC charging pile, solar photovoltaic and other occasions. Its complete communication function makes it very suitable for real-time power monitoring systems.

Part 2 General Specifications

2.1 Specifications

- ◆ Voltage: : Rated Voltage (U_n) L-N 100 to 276V a.c. (not for 3p3w supplies)

173 to 480V AC. (3p supplies only)

Primary Voltage: 20V-500kV

Second Voltage: 100-500V

Auxiliary Supply: 85~275V AC
- ◆ Current: Primary Current :1-9999A

Second Current: 1A or 5A

Over current withstand: 20 I_{max} for 0.01s
- ◆ Operational frequency: Rated: 50/60Hz

Range: 45-65 Hz
- ◆ Insulation capabilities: AC voltage withstand 4KV/1min

Impulse voltage withstand 6kV – 1.2 μ S waveform
- ◆ Internal Power Consumption: $\leq 2W$.
- ◆ Pulse Output 1: Configurable
- ◆ Pulse Output 2: Fixed 3200imp/kWh
- ◆ Display: LCD with backlit
- ◆ Max Reading: 9999999.9 kWh / kVA r_h

2.2 Accuracy

- ◆ Voltage: 0.2%
- ◆ Current: 0.2%
- ◆ Frequency: 0.2%
- ◆ Power Factor: 0.5%

- ◆ Active Power: 0.5%
- ◆ Reactive Power: $\pm 0.5\%$
- ◆ Apparent power: $\pm 0.5\%$
- ◆ Active energy: Class 0.5S
- ◆ Reactive energy: Class2

2.3 RS485 Communication

- ◆ Bus Type: RS485
- ◆ Communication Protocol: Modbus RTU
- ◆ Baud rate: 2400/4800/9600/19200/38400bps
- ◆ Modbus Address: 1-247
- ◆ Bus load: 64pcs
- ◆ Communication distance: 1000m
- ◆ Parity: EVEN /ODD/NONE
- ◆ Data bit: 8
- ◆ Stop bit: 1

2.4 Environment

- ◆ Operating humidity: $\leq 90\%$
- ◆ Storage humidity: $\leq 95\%$
- ◆ Operating temperature: $-25^{\circ}\text{C}\sim+55^{\circ}\text{C}$
- ◆ Storage temperature: $-40^{\circ}\text{C}\sim+70^{\circ}\text{C}$
- ◆ Standard: IEC 63052-11/IEC62053-22
- ◆ Accuracy: Class 0.5S
- ◆ Installation category: CAT III

- ◆ Protection against penetration of dust and water: IP51 (indoor)
- ◆ Insulating encased meter of protective class: II
- ◆ Altitude: ≤2000m

2.5 Dimensions

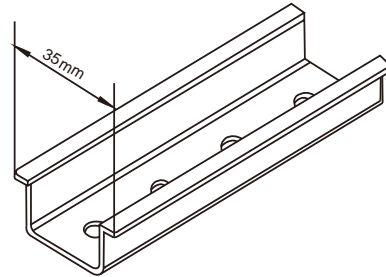
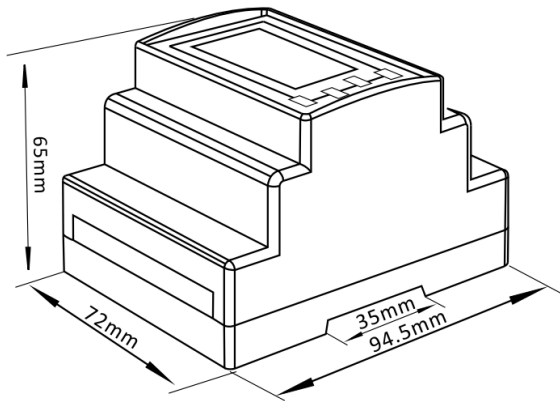

Height: 65 mm

Width: 72 mm

Length: 94.5 mm

2.6 Wiring Diagram

3P4W

3P3W

1P2W

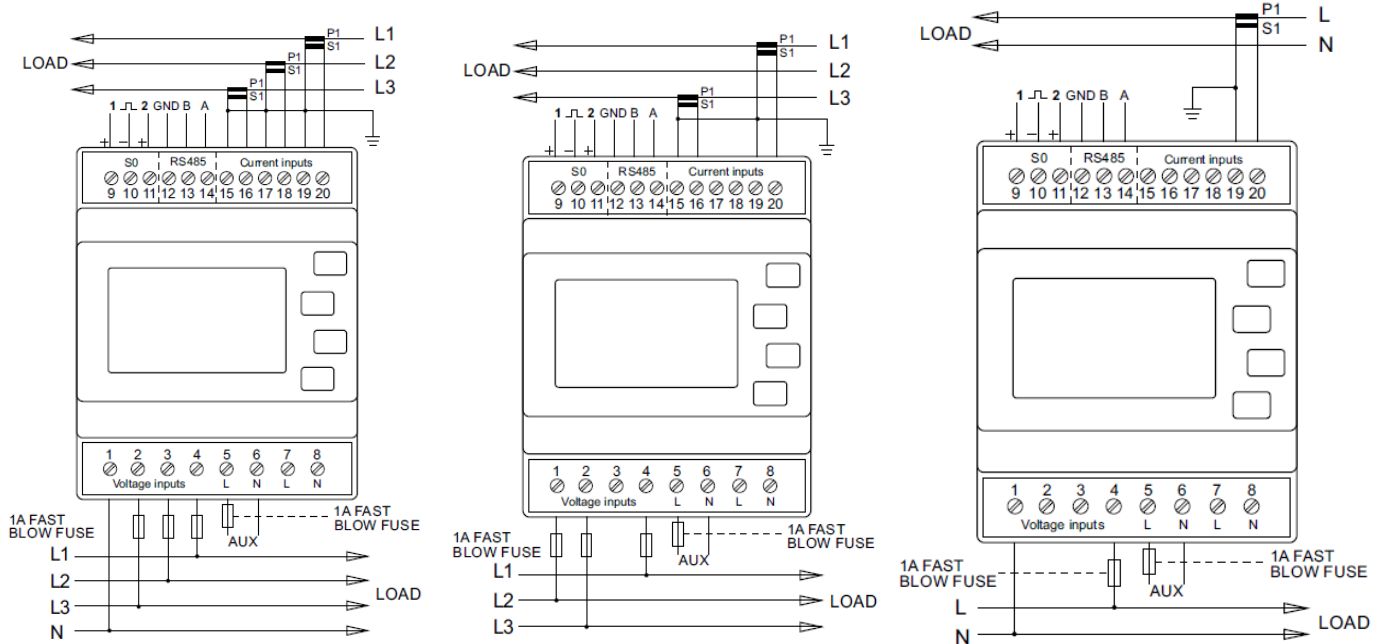

Part 3. Operation Instructions





3.1 Display and Operation

When the meter is powered on, the meter will initialize and do self-checking

Display as following:

1	Full screen
2	Software version
3	Self-checking finish





3.1.1 Button Definition

	<p>Selects V and A display screen.</p> <p>In Set-up Mode, it is the “Left” or “Back” button</p>
	<p>Selects Hz and PF display screen.</p> <p>In Set-up Mode, it is the “Up” button</p>
	<p>Selects power display screen.</p> <p>In Set-up Mode, it is the “Down” button</p>
	<p>Selects energy display screen.</p> <p>In Set-up Mode, it is the “Enter” or “Right” button.</p>

3.2 Measurement

3.2.1 Voltage & Current

Press button  :

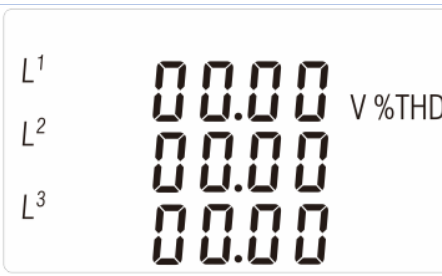

1		Phase to neutral voltages(3p4w)
1-1		Phase to phase voltages(3p3w)
2		Current on each phase
3		Neutral current
4		Phase to neutral voltage THD%(3p4w)

5		Current THD% for each phase
---	---	-----------------------------

3.2.2 Frequency, Power Factor & Demand

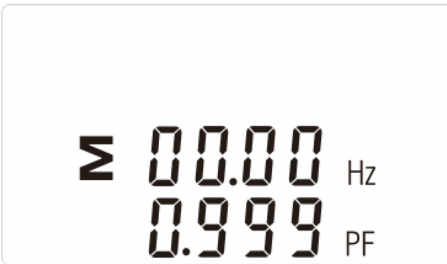

Press button :

1		Frequency and Power Factor (total)
2		Power Factor of each phase
3		Maximum Current Demand

4		Maximum Power Demand
---	---	----------------------

3.2.3 Power

Press  :



1		Instantaneous Active Power in kW
2		Instantaneous Reactive Power in kVAr
3		Instantaneous Volt-amps in KVA



4		Total kW, kVAr, kVA
---	---	---------------------

3.2.4 Energy

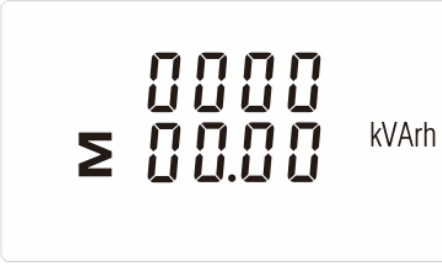

Press button :

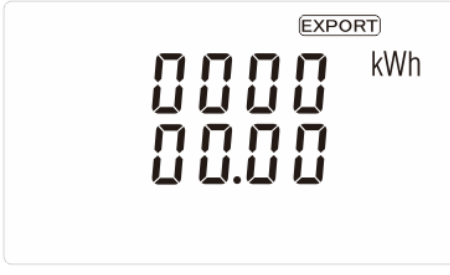
1		Total active energy in kWh
2		Total reactive energy in kVArh
3		Imported active energy in kWh

4		Exported active energy in kWh
5		Imported reactive energy in kVArh
6		Exported reactive energy in kVArh

3.3 Setting by button

To enter set-up mode, pressing the  button for 3 seconds, until the password screen appears.





Setting up is password-protected so you must enter the correct password (default '1000') before processing. If an incorrect password is entered, the display will show: Err



To exit setting-up mode, press  repeatedly until the measurement screen is restored.

3.3.1 Button Operation



1. After Entering the Setting menu, use the  and  buttons to select the required item from the menu. Selection does not roll over between bottom and top of list

2. Press  for 3s to confirm your selection.

3. If an item flashes, then it can be adjusted by the  and  buttons. If not, there may be a further layer.

4. Having selected an option from the current layer, press  to confirm your selection. The SET indicator will appear.

5. Having completed a parameter setting, press  to return to a higher menu level. The SET

indicator will be removed and you will be able to use the  and  buttons for further menu selection.

6. On completion of all set-up, press  repeatedly until the measurement screen is restored.

3.3.2 Number Entry Procedure

When setting up the unit, some screens require the entering of a number. In particular, on entry to the setting up section, a password must be entered. Digits are set individually, from left to right. The procedure is as follows:

1. The current digit to be set flashes and is set using the



and







2. Press  to confirm each digit setting. The SET indicator appears after the last digit has been set.





3. After setting the last digit, press



to exit the number setting routine. The SET indicator will be removed.

3.3.3 Set Password





1		<p>Use the  and  to choose the change password option</p>
2-1		<p>Press the  to enter the change password routine. The new password screen will appear with the first digit flashing</p>



2-2		<p>Use  and  to set the first digit and press  to confirm your selection. The next digit will flash.</p>
<p>Press  to exit the number setting routine and return to the Set-up menu. SET will be removed</p>		

3.3.4 Modbus Address











(The range is from 001 to 247)

1		<p>From the Set-up menu, use  and  buttons to select the Address ID</p>
2-1		<p>Press  button to enter the selection routine. The current setting will be flashing.</p>

2-2		Use  and  buttons to choose Modbus Address(001 to 247)
-----	---	---

3.3.5 Baud Rate

Options: 2.4k, 4.8k, 9.6k, 19.2k, 38.4k.

1		From the Set-up menu, use  and  buttons to select the Baud Rate option.
2-1		Press  to enter the selection routine. The current setting will flash.
2-2		Use  and  buttons to choose Baud rate 2.4k. 4.8k, 9.6k, 19.2k, 38.4k

3.3.6 Parity





Options: EVEN / ODD / NONE.

1		<p>From the Set-up menu, use and buttons to select the Parity option.</p>
2-1		<p>Press to enter the selection routine. The current setting will flash.</p>
2-2		<p>Use and buttons to choose Parity (EVEN / ODD / NONE)</p>

3.3.7 Stop bit

Option: 1 or 2.







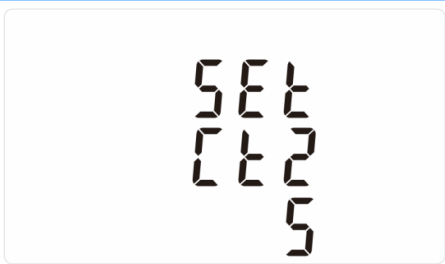

1		<p>From the Set-up menu, use and buttons to select the Stop Bit option.</p>
---	--	---

2		<p>Press  to enter the selection routine. The current setting will flash.</p> <p>Use  and  buttons to choose Stop Bit (2 or 1)</p>
---	---	--

Note: Default is 1, and only when the parity is NONE that the stop bit can be changed to 2.

3.3.8 CT Setting







The CT option sets the secondary current (CT2 1A or 5A) of the current transformer (CT) that wires to the meter.

1		<p>From the Set-up menu, use  and  buttons to select the CT option.</p>
2		<p>Secondary CT setting</p> <p>Press  to enter the CT secondary current selection routine.:5A/1A</p>
3		<p>Set CT Ratio value Press  to enter the CT Ratio setting screen. Use  and  buttons to choose the CT ratio. The range is from 0001 to 2000.</p>

Example: If set the ratio to be 100, it means the primary current equals secondary current x 100

3.3.9 PT Setting







The PT option sets the secondary voltage (PT2 100 to 500V) of the Voltage transformer (PT) that wires to the meter.

1		<p>From the Set-up menu, use  and  buttons to select the PT option. The screen will show the voltage PT secondary voltage value. The default value is 400V</p>
2		<p>Secondary PT setting</p> <p>Press  to enter the PT secondary voltage selection routine. The range is from 100 to 500V</p>
3		<p>Set PT ratios value</p> <p>Press  to enter the PT ratio screen.</p> <p>The range is from 0001 to 2000</p>
<p>For example, if set the ratio to be 100, it means the primary voltage equals secondary voltage x 100</p>		

3.3.10 Pulse Output

This option allows you to configure the pulse output. The output can be set to provide a pulse for a defined amount of energy active or reactive.

Use this section to set up the pulse output 1—Units: Total kWh, Total kVArh

1		<p>From the Set-up menu, use  and  buttons to select the Pulse output option.</p>
2		<p>Press  to enter the selection routine. The unit symbol will flash.</p> <p>Use  and  buttons to choose kWh or kVArh.</p> <p>On completion of the entry procedure, press  to confirm the setting and press  to return to the main set up menu.</p>

3.3.11 Pulse Constant

Use this to set the energy represented by each pulse. Rate can be set to 1 pulse per

0.01kWh/0.1kWh/1kWh/10kWh/100/1000kWh.



(It shows 1 impulse = 10kWh/kVArh)







1	<p>The image shows a digital LCD display with three lines of text. The top line displays 'SET', the middle line displays 'RATE', and the bottom line displays the number '10'. The text is in a simple, blocky font.</p>	<p>From the Set-up menu, use and buttons to select the Pulse Rate option.</p>
2	<p>The image shows a digital LCD display with three lines of text. The top line displays 'SET', the middle line displays 'RATE', and the bottom line displays the number '10'. The number '10' is highlighted in red.</p>	<p>Press to enter the selection routine. The current setting will flash. Use and buttons to choose the Pulse Constant. Press to confirm the setting and press to return to the main set up menu.</p>

3.3.12 Pulse Duration

The energy monitored can be active or reactive and the pulse width can be selected as 200, 100(default) or 60ms.











(It shows pulse width of 200ms)

1	<p>The image shows a digital LCD display with the text 'SET' on the top line, 'PULS' on the second line, and '200' on the third line. The digits are in a black, seven-segment font.</p>	<p>From the Set-up menu, use  and  buttons to select the Pulse width option.</p>
2	<p>The image shows a digital LCD display with the text 'SET' on the top line, 'PULS' on the second line, and '200' on the third line. The '200' is highlighted in red.</p>	<p>Press  to enter the selection routine. The current setting will flash.</p> <p>Use  and  buttons to choose pulse width. On Completion of the entry procedure, press  to confirm the setting and press  to return to the main set up menu.</p>





3.3.13 Demand Integration Time

This sets the period in minutes over which the current and power readings are integrated for maximum demand measurement. The options are: 0, 5, 8, 10, 15, 20, 30, 60 minutes

1		<p>From the set-up menu, use  and  buttons to select the DIT option. The screen will show the currently selected integration time.</p>
2		<p>Press  to enter the selection routine.</p> <p>The current time interval will flash</p> <p>Use  and  buttons to select the time required.</p> <p>Press  to confirm the selection. SET indicator will appear.</p>
<p>Press  to exit the DIT selection routine and return to the menu.</p>		









3.3.14 Set backlit lasting time

1		<p>The backlit lasting time is settable</p> <p>Default lasting time is 60minutes</p> <p>For example, if it's set as 5, the backlit will be off in 5minutes from the last time operation on the meter.</p>
---	---	---

2		<p>Press  to enter the selection routine. The current time interval will flash</p> <p>The options can be: 0(always on),5,10,30,60,120minutes</p> <p>Use  and  buttons to select the time required. Press  to confirm the set-up,</p>
---	---	--







3.3.15 Set System

Use this section to set the type of power supply being monitored.

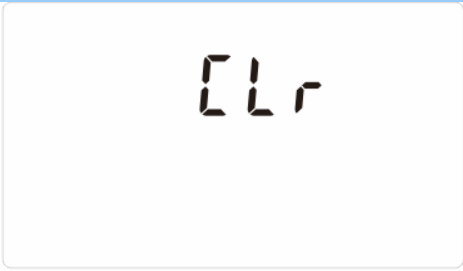
1		<p>From the Set-up menu, use  and  buttons to select the System option. The screen will show the currently selected power supply.</p>
2		<p>Press  to enter the selection routine. The current selection will flash. Use  and  buttons to select the required system option: 1P2(W), 3P3(W) ,3P4(W). Press  to confirm the selection. SET indicator will appear. Press  to exit the system selection routine and return to the menu. SET will disappear and you will be returned to the main Set-up Menu.</p>

3.3.16 Clear

The meter provides a function to reset the maximum demand value of current and power.

1		<p>From the Set-up menu, use  and  buttons to select the reset option.</p>
2		<p>Press  to enter the selection routine. The MD will flash.</p> <p>Press  to confirm the setting and press  to return to the main set up menu.</p>

Part 4. Modbus register Map

Function code	
04	to read input parameters

Address (Register)	Input Register Parameter	Length of the byte	Data Format	unit	Modbus Protocol Start Address Hex		3	3	1
					High Byte	Low Byte	∅	∅	∅
	Parameter						4 W	3 W	2 W
0001	Phase 1 line to neutral volts.	4	Float	V	00	00	√	X	√
0003	Phase 2 line to neutral volts.	4	Float	V	00	02	√	X	X
0005	Phase 3 line to neutral volts.	4	Float	V	00	04	√	X	X
0007	Phase 1 current.	4	Float	A	00	06	√	√	√
0009	Phase 2 current.	4	Float	A	00	08	√	√	X
0011	Phase 3 current.	4	Float	A	00	0A	√	√	X
0013	Phase 1 power.	4	Float	W	00	0C	√	X	√
0015	Phase 2 power.	4	Float	W	00	0E	√	X	X
0017	Phase 3 power.	4	Float	W	00	10	√	X	X
0019	Phase 1 volt amps.	4	Float	VA	00	12	√	X	√
0021	Phase 2 volt amps.	4	Float	VA	00	14	√	X	X

0023	Phase 3 volt amps.	4	Float	VA	00	16	√	X	X
0025	Phase 1 Reactive Power	4	Float	VAr	00	18	√	X	√
0027	Phase 2 Reactive Power	4	Float	VAr	00	1A	√	X	X
0029	Phase 3 Reactive Power	4	Float	VAr	00	1C	√	X	X
0031	Phase 1 power factor	4	Float	None	00	1E	√	X	√
0033	Phase 2 power factor	4	Float	None	00	20	√	X	X
0035	Phase 3 power factor	4	Float	None	00	22	√	X	X
0037	Phase 1 phase angle.	4	Float	Degrees	00	24	√	X	√
0039	Phase 2 phase angle.	4	Float	Degrees	00	26	√	X	X
0041	Phase 3 phase angle.	4	Float	Degrees	00	28	√	X	X
0043	Average line to neutral volts.	4	Float	V	00	2A	√	X	X
0047	Average line current.	4	Float	A	00	2E	√	√	√
0049	Sum of line currents.	4	Float	A	00	30	√	√	√
0053	Total system power.	4	Float	W	00	34	√	√	√
0057	Total system volt amps.	4	Float	VA	00	38	√	√	√
0061	Total system VAr.	4	Float	VAr	00	3C	√	√	√
0063	Total system power factor	4	Float	None	00	3E	√	√	√
0067	Total system phase angle.	4	Float	Degrees	00	42	√	√	√

0071	Frequency of supply voltages.	4	Float	Hz	00	46	√	√	√
0073	Total Import kWh	4	Float	kWh	00	48	√	√	√
0075	Total Export kWh.	4	Float	kWH	00	4A	√	√	√
0077	Total Import kVArh .	4	Float	kVArh	00	4C	√	√	√
0079	Total Export kVArh .	4	Float	kVArh	00	4E	√	√	√
0081	Total VAh	4	Float	kVAh	00	50	√	√	√
0083	Ah	4	Float	Ah	00	52	√	√	√
0085	Total system power demand	4	Float	W	00	54	√	√	√
0087	Maximum total system power demand	4	Float	W	00	56	√	√	√
0101	Total system VA demand.	4	Float	VA	00	64	√	√	√
0103	Maximum total system VA demand.	4	Float	VA	00	66	√	√	√
0105	Neutral current demand.	4	Float	Amps	00	68	√	X	X
0107	Maximum neutral current demand.	4	Float	Amps	00	6A	√	X	X
0109	Total system reactive power demand	4	Float	VAr	00	6C	√	X	√
0111	Maximum total system reactive power demand	4	Float	VAr	00	6E	√	X	√
0201	Line 1 to Line 2 volts.	4	Float	V	00	C8	√	√	X
0203	Line 2 to Line 3 volts.	4	Float	V	00	CA	√	√	X
0205	Line 3 to Line 1 volts.	4	Float	V	00	CC	√	√	X
0207	Average line to line volts.	4	Float	V	00	CE	√	√	X

0225	Neutral current.	4	Float	A	00	E0	√	X	X
0235	Phase 1 L/N volts THD	4	Float	%	00	EA	√	X	√
0237	Phase 2 L/N volts THD	4	Float	%	00	EC	√	X	X
0239	Phase 3 L/N volts THD	4	Float	%	00	EE	√	X	X
0241	Phase 1 Current THD	4	Float	%	00	F0	√	√	√
0243	Phase 2 Current THD	4	Float	%	00	F2	√	√	X
0245	Phase 3 Current THD	4	Float	%	00	F4	√	√	X
0249	Average line to neutral volts THD.	4	Float	%	00	F8	√	X	√
0251	Average line current THD.	4	Float	%	00	FA	√	√	√
0259	Phase 1 current demand.	4	Float	A	01	02	√	√	√
0261	Phase 2 current demand.	4	Float	A	01	04	√	√	X
0263	Phase 3 current demand.	4	Float	A	01	06	√	√	X
0265	Maximum phase 1 current demand.	4	Float	A	01	08	√	√	√
0267	Maximum phase 2 current demand.	4	Float	A	01	0A	√	√	X
0269	Maximum phase 3 current demand.	4	Float	A	01	0C	√	√	X
0335	Line 1 to line 2 volts THD.	4	Float	%	01	4E	√	√	X
0337	Line 2 to line 3 volts THD.	4	Float	%	01	50	√	√	X
0339	Line 3 to line 1 volts THD.	4	Float	%	01	52	√	√	X
0341	Average line to line volts THD.	4	Float	%	01	54	√	√	X

0343	Total kwh	4	Float	kWh	01	56	√	√	√
0345	Total kvarh	4	Float	kVArh	01	58	√	√	√
0347	L1 import kwh	4	Float	kWh	01	5A	√	√	√
0349	L2 import kwh	4	Float	kWh	01	5C	√	√	X
0351	L3 import kWh	4	Float	kWh	01	5E	√	√	X
0353	L1 export kWh	4	Float	kWh	01	60	√	√	√
0355	L2 export kwh	4	Float	kWh	01	62	√	√	X
0357	L3 export kWh	4	Float	kWh	01	64	√	√	X
0359	L1 total kwh	4	Float	kWh	01	66	√	√	√
0361	L2 total kWh	4	Float	kWh	01	68	√	√	X
0363	L3 total kwh	4	Float	kWh	01	6A	√	√	X
0365	L1 import kvarh	4	Float	kVArh	01	6C	√	√	√
0367	L2 import kvarh	4	Float	kVArh	01	6E	√	√	X
0369	L3 import kvarh	4	Float	kVArh	01	70	√	√	X
0371	L1 export kvarh	4	Float	kVArh	01	72	√	√	√
0373	L2 export kvarh	4	Float	kVArh	01	74	√	√	X
0375	L3 export kvarh	4	Float	kVArh	01	76	√	√	X
0377	L1 total kvarh	4	Float	kVArh	01	78	√	√	√

0379	L2 total kvarh	4	Float	kVArh	01	7A	√	√	X
0381	L3 total kvarh	4	Float	kVArh	01	7C	√	√	X
0385	resettable total active energy	4	Float	kWh	01	80	√	√	√
0387	resettable total reactive energy	4	Float	kVArh	01	82	√	√	√
0389	resettable import active energy	4	Float	kWh	01	84	√	√	√
0391	resettable export active energy	4	Float	kWh	01	86	√	√	√
0393	resettable import reactive energy	4	Float	kVArh	01	88	√	√	√
0395	resettable export reactive energy	4	Float	kVArh	01	8A	√	√	√

Function code	
10	to set holding parameter
03	to read holding parameter

Address Register	Parameter Number	Parameter	Modbus Protocol Start Address Hex		Valid range	Mode
			High Byte	Low Byte		
0003	2	Demand Period	00	02	Write demand period: 0, 5,8, 10, 15, 20, 30 or 60 minutes, default 60. Setting the period to 0 will cause the demand to show the Current parameter value and demand	r/w

					<p>max to show the maximum parameter value since last demand reset.</p> <p>Length : 4 byte</p> <p>Data Format : Float</p>	
0011	6	System Type	00	0A	<p>Write system type: 3p4w = 3, 3p3w = 2 & 1p2w= 1</p> <p>Requires password, see parameter 13</p> <p>Length : 4 byte</p> <p>Data Format : Float</p>	r/w
0013	7	Pulse1 Width	00	0C	<p>Write pulse1 on period in milliseconds: 60, 100 or 200, default 100.</p> <p>Length : 4 byte</p> <p>Data Format : Float</p>	r/w
0015	8	Password Lock	00	0E	<p>Write any value to password lock protected registers.</p> <p>Read password lock status:</p> <p>0 = locked. 1 = unlocked.</p> <p>Reading will also reset the password timeout back to one minute.</p> <p>Length : 4 byte</p> <p>Data Format : Float</p>	r
0019	10	Network Parity Stop	00	12	<p>Write the network port parity/stop bits for MODBUS Protocol, where: 0 = One stop bit and no parity, default. 1 = One stop bit and even parity. 2 = One stop bit and odd parity. 3 = Two stop bits and no parity. Requires a restart to become</p>	r/w

					effective. Length : 4 byte Data Format : Float	
0021	11	Network Node	00	14	Write the network port node address: 1 to 247 for MODBUS Protocol, default 1. Requires a restart to become effective. Length : 4 byte Data Format : Float	r/w
0023	12	Pulse 1 Divisor	00	16	Write pulse divisor index: n = 1 to 6 1--0.01kwh/imp 2--0.1kwh/imp 3--1kwh/imp 4-10kwh/imp 5-100kwh/imp 6-1000kwh/imp Length : 4 byte Data Format : Float	r/w
0025	13	Password	00	18	Write password for access to protected registers. Default password is 1000. Length : 4 byte Data Format : Float	r/w
0029	15	Baud Rate	00	1C	Write the baud rate for MODBUS Protocol, where:	r/w

					<p>0 = 2400 baud. 1 = 4800 baud.</p> <p>2 = 9600 baud, default.</p> <p>3 = 19200 baud. 4 = 38400 baud.</p> <p>Length : 4 byte</p> <p>Data Format : Float</p>	
0063	32	CT ratio	00	3E	<p>CT Ratio range:1~2000</p> <p>CT Ratio= primary current /secondary current</p> <p>Length : 4 byte</p> <p>Data Format : Float</p> <p>Requires password, see parameter 13</p>	r/w
0065	33	PT ratio	00	40	<p>PT Ratio range:1~2000</p> <p>PT ratio= primary voltage /secondary voltage</p> <p>Length : 4 byte</p> <p>Data Format : Float</p> <p>Requires password, see parameter 13</p>	r/w
0087	44	Pulse 1 Energy Type	00	56	<p>Write MODBUS Protocol</p> <p>input parameter for pulse</p> <p>out 1: 37 = total kwh or 39 = total kVarh, default 39.</p> <p>Length : 4 byte</p> <p>Data Format : Float</p>	r/w
61457	30729	Reset	F0	10	<p>00 00 : reset the Maximum demand</p> <p>00 03: reset the resettable energy</p>	wo

					Length : 2 byte Data Format: Hex	
64513	32257	Serial number	FC	00	Serial number Length: 4 byte Data Format: unsigned int32 Note: Only read	ro